



Traditional High Q (>10,000) Low ESR
Multi-Layer Ceramic Capacitors

0505C/P (0.055" x 0.055")

≠ Product Features

- High Q
- High Power
- Low ESR/ESL
- Low Noise
- High Self-Resonance
- Ultra Stable Performance
- Capacitance Range:
0.1pF to 1000pF
- Working Voltage: 150V
- Extended Voltage: 300V

≠ Product Applications

Typical Functional Applications:

- Tuning • Bypass • Coupling
- Feedback • D.C. Blocking
- Impedance Matching

Typical Circuit Applications:

- UHF/Microwave RF Power Amplifiers
- Mixers • Oscillators • Filter Networks
- Low Noise Amplifiers • Timing Circuits
and Delay Lines



Marking shown for illustration purposes only.
Actual marking may differ.

≠ Part Numbering

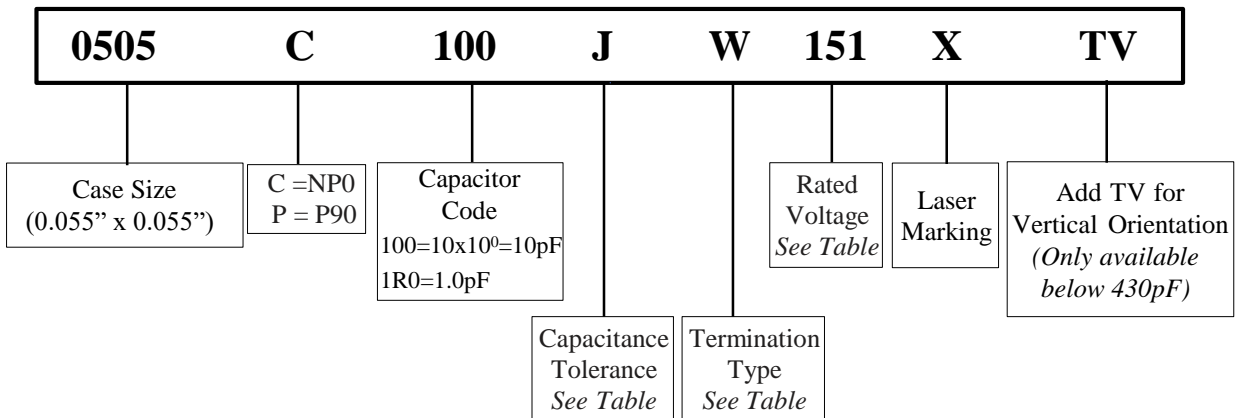

≠ Capacitance Tolerance Codes

Code	A	B	C	D	F	G	J	K
Tol.	±0.05pF	±0.1pF	±0.25pF	±0.5pF	±1%	±2%	±5%	±10%

≠ Voltage Codes

Voltage	Code	Voltage	Code
50V	500	200V	201
100V	101	250V	251
150V	151	300V	301

Please note that the contents of this document are subject to change at any time at PPI's sole discretion. The most up-to-date version of this document is available at www.passiveplus.com



Traditional High Q (>10,000) Low ESR
Multi-Layer Ceramic Capacitors

0505C/P (0.055" x 0.055")

≠ 0505C/P Capacitance Values

- NP0=C; P90=P
- **Maximum Capacitance: 0505P=100pF; 0505C=1000pF**
- * - Available in NP0 only.

Special capacitances, tolerances and WVDC are available. Please contact PPI.

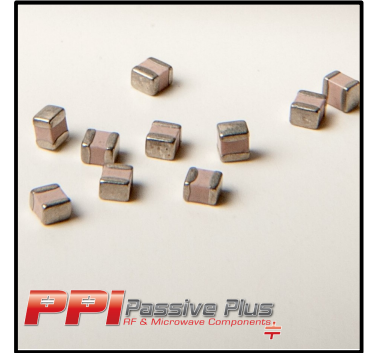

Cap. pF	Cap Code	Tol.	Rated WVDC		Cap. pF	Cap Code	Tol.	Rated WVDC		Cap. pF	Cap Code	Tol.	Rated WVDC		Cap. pF	Cap Code	Tol.	Rated WVDC	
			Std.	Ext.				Std.	Ext.				Std.	Ext.				Std.	Ext.
0.1	0R1				2.4	2R4				20	200				160	161*			
0.2	0R2				2.7	2R7				22	220				180	181*			
0.3	0R3				3.0	3R0				24	240				200	201*			
0.4	0R4				3.3	3R3				27	270				220	221*	F,G, J,K	150V	200V
0.5	0R5				3.6	3R6				30	300	F,G, J,K	150V	250V or 300V	240	241*			
0.6	0R6				3.9	3R9				33	330				270	271*			
0.7	0R7				4.3	4R3				36	360				300	301*			
0.8	0R8				4.7	4R7	A,B, C,D	150V	250V or 300V	39	390				330	331*			
0.9	0R9				5.1	5R1				43	430				360	361*			
1.0	1R0				5.6	5R6				47	470				390	391*			
1.1	1R1	A,B, C,D	150V	250V or 300V	6.2	6R2				51	510				430	431*	F,G, J,K	150V	N/A
1.2	1R2				6.8	6R8				56	560				470	471*			
1.3	1R3				7.5	7R5				62	620				510	511*			
1.4	1R4				8.2	8R2				68	680				560	561*			
1.5	1R5				9.1	9R1				75	750				620	621*			
1.6	1R6				10	100				82	820	F,G, J,K	150V	200V	680	681*			
1.7	1R7				11	110				91	910				750	751*			
1.8	1R8				12	120	F,G, J,K	150V	250V or 300V	100	101				820	821*	F,G, J,K	50V	100V
1.9	1R9				13	130				110	111*				910	911*			
2.0	2R0				15	150				120	121*				1000	102*			
2.1	2R1				16	160				130	131*								
2.2	2R2				18	180				150	151*								

*Available in NP0 only



Traditional High Q (>10,000) Low ESR
Multi-Layer Ceramic Capacitors

0505C/P (0.055" x 0.055")

≠ Termination Types and Codes

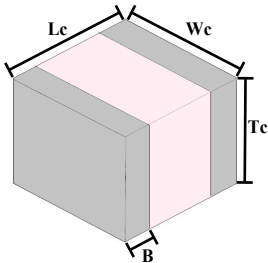

Chip Termination:
Codes: **W, L, P**

Magnetic Terminations	
Termination Code	Termination
W	100% Tin Solder over Nickel Barrier
L	90%Tin/10%Lead Solder over Nickel Barrier
Non-Magnetic Terminations	
Termination Code	Termination
P	100% Tin Solder over Copper Barrier

≠ Dimensions Unit: inch (millimeter)

Magnetic Termination						
Code		Length		Width	Thickness	Overlap
		Lc		Wc	Tc	B
W/L	Chip	0.055	+0.015 -0.010	0.055 ± 0.010	0.057 max	0.014 ± 0.006
		(1.40	+0.38 -0.25)	(1.40 ± 0.25)	(1.45 max)	(0.356 ± 0.152)
Non-Magnetic Termination						
Code		Length		Width	Thickness	Overlap
		Lc		Wc	Tc	B
P	Chip	0.055	+0.015 -0.010	0.055 ± 0.010	0.057 max	0.014 ± 0.006
		(1.40	+0.38 -0.25)	(1.40 ± 0.25)	(1.45 max)	(0.356 ± 0.152)

Note: "Non-Magnetic" means no magnetic materials.



Traditional High Q (>10,000) Low ESR
Multi-Layer Ceramic Capacitors

0505C/P (0.055" x 0.055")

≠ Electrical Specifications

Quality Factor (Q)	Greater than 10,000 at 1 MHz
Insulation Resistance (IR)	10 ⁵ MegaOhms min. @ +25°C rated WVDC 10 ⁴ MegaOhms min. @ +125°C rated WVDC
Rated Voltage	See Rated Voltage in Capacitance Table
Dielectric Withstanding Voltage (DWV)	250% of Rated Voltage of 5 seconds
Operating Temperature Range	-55°C to 200°C
Temperature Coefficient (TC)	C: -55°C to 125°C 0±30ppm/°C; >125°C to 200°C 0±60ppm/°C P: -55°C to 200°C +90±20ppm/°C
Capacitance Drift	±0.02% or ±0.02pF, whichever is greater
Piezoelectric Effects	None
Termination Type	See Termination Type Table

Capacitors are designed and manufactured to meet the requirements of MIL-PRF-55681 and MIL-PRF-123.

≠ Environmental Specifications

	Specification	Test Parameters
Thermal Shock	DWV: The initial Value IR: Shall not be less than 30% of the initial value. Capacitance Change:	MIL-STD-202, Method 107, Condition A. At the maximum rated temperature (-55°C and 200°C) stay 30 minutes, the time of removing shall not be more than 3 minutes. Perform five cycles.
Moisture Resistance	No more than 0.5% or 0.5pF, whichever is greater.	MIL-STD-202, Method 106
Humidity (Steady State)	DWV: The initial Value IR: The initial value. Capacitance Change: No more than 0.5% or 0.5pF, whichever is greater.	MIL-STD-202, Method 103, Condition A With 1.5Volts DC applied while subjected to an environment of 85°C with 85% relative humidity for 240 hours minimum.
Life	IR: Shall not be less than 30% of the initial value. Capacitance Change: No more than 2.0% or 0.5pF, whichever is greater.	MIL-STD-202, Method 108. For 2000 hours, at 200°C. Rated Voltage DC applies.
Terminal Strength	Force: 10lbs typical, 5lbs. Minimum. Duration Time: 5 to 10 seconds	MIL-STD-202, Method 211A, Test Condition A. Applied a force and maintained for a period of 5 to 10 seconds. The force shall be in the direction of the axes of the terminations.



Traditional High Q (>10,000) Low ESR
Multi-Layer Ceramic Capacitors

0505C/P (0.055" x 0.055")

≠ FPR -- First Parallel Resonance (FPRs)

≠ Definitions and Measurement Conditions

The **First Parallel Resonance, FPR**, is defined as the lowest frequency at which a suckout or notch appears in $|S_{21}|$.

It is generally independent of substrate thickness or dielectric constant, but does depend on capacitor orientation. A horizontal orientation means the capacitor electrode planes are parallel to the plane of the substrate; a vertical orientation means the electrode planes are perpendicular to the substrate.

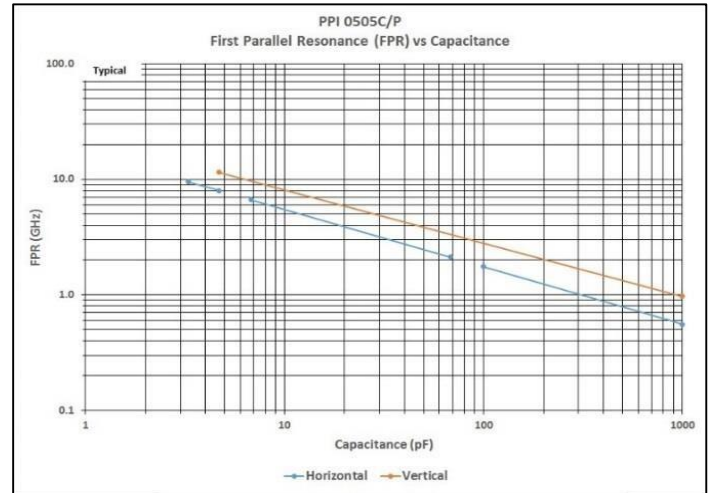

≠ FSR -- First Series Resonance (FSRs)

≠ Definitions and Measurement Conditions

The **First Series Resonance, FSR**, is defined as the lowest frequency at which the imaginary part of the input impedance, $\text{Im}[Z_{in}]$, equals zero. Should $\text{Im}[Z_{in}]$ or the real part of the input impedance, $\text{Re}[Z_{in}]$, not be monotonic with frequency at frequencies lower than those at which $\text{Im}[Z_{in}] = 0$, the FSR shall be considered as undefined (represented as a gap in the plot). FSR is dependent on internal capacitor structure; substrate thickness and dielectric constant; capacitor orientation, as defined alongside the FPR plot; and mounting pad dimensions.

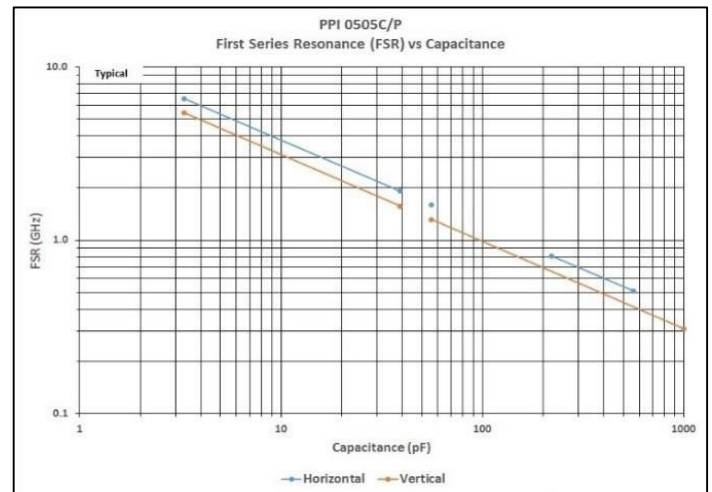

The measurement conditions are: substrate – Rogers RO4350; substrate dielectric constant = 3.66; horizontal mount substrate thickness (mils) = 25; gap in microstrip trace (mils) = 15; horizontal mount microstrip trace width (mils) = 55. Reference planes at sample edges.

All data has been derived from electrical models created by Modelithics, Inc., a specialty vendor contracted by PPI. The models are derived from measurements on a large number of parts disposed on several different substrates.



Traditional High Q (>10,000) Low ESR
Multi-Layer Ceramic Capacitors

0505C/P (0.055" x 0.055")

⚡ ESR vs. Frequency

0505C/P ESR vs Frequency

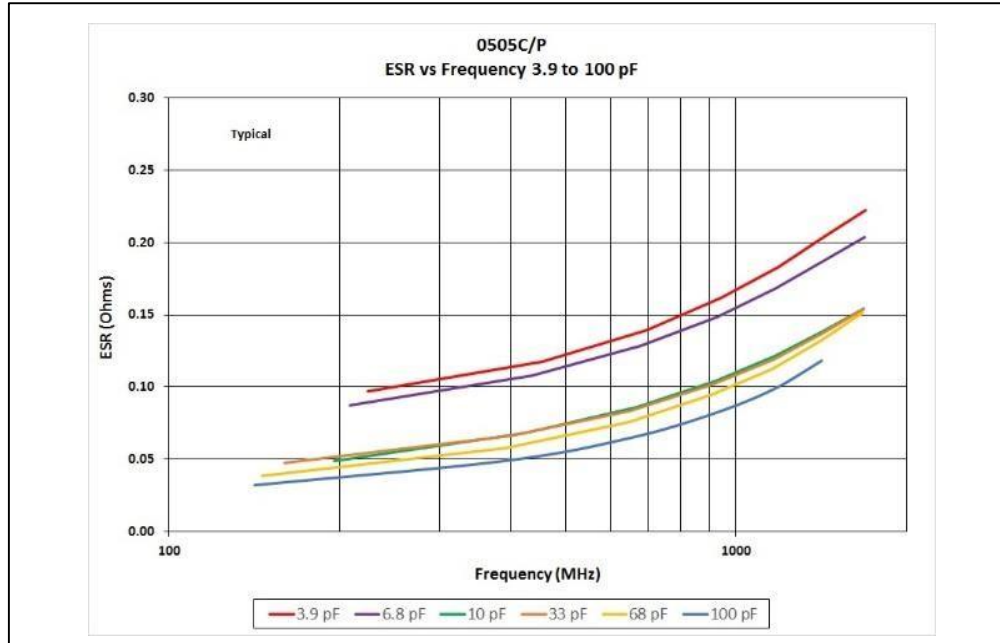

0505C ESR vs Frequency

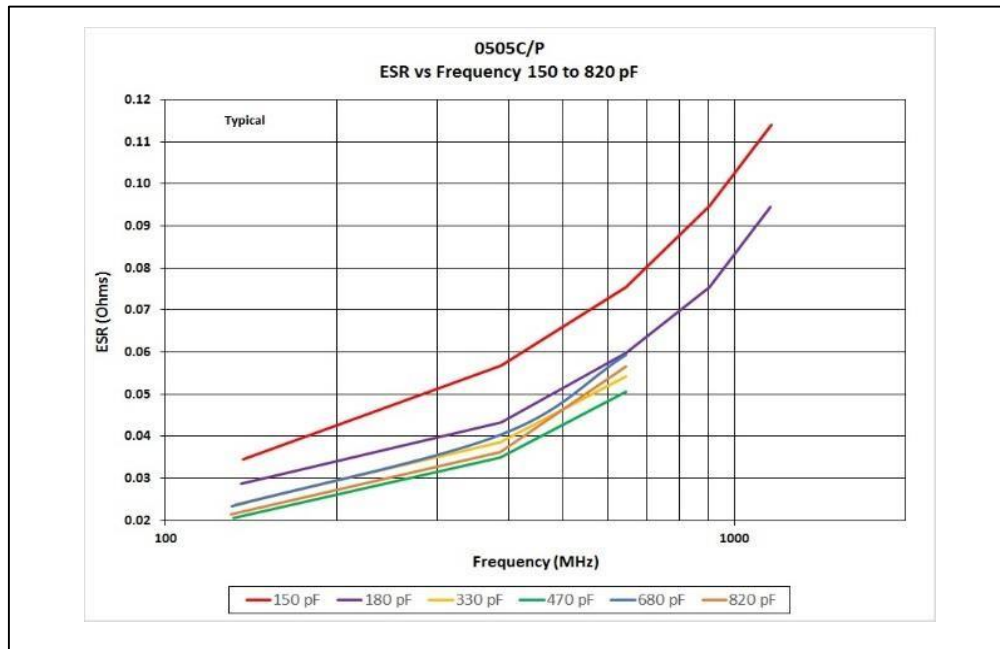



Traditional High Q (>10,000) Low ESR
Multi-Layer Ceramic Capacitors

0505C/P (0.055" x 0.055")

≠ Q vs. Frequency

0505C/P Q vs Frequency

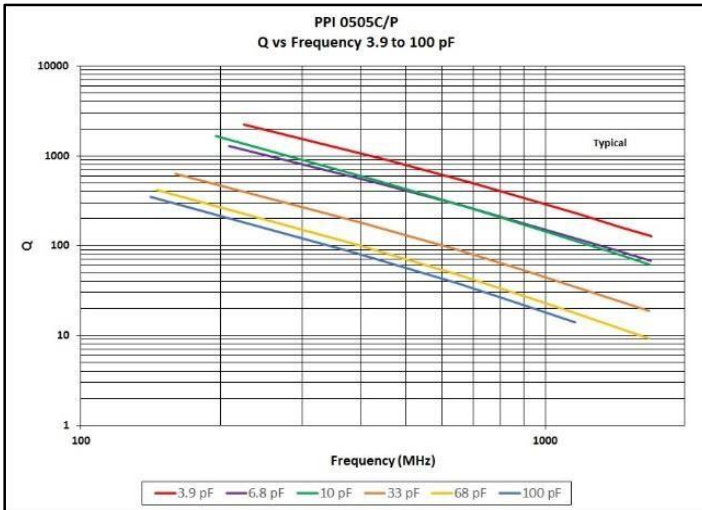

0505C Q vs Frequency

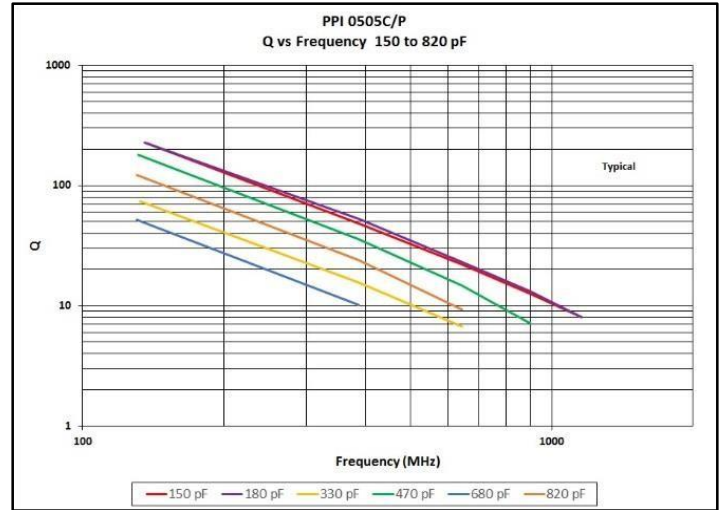

≠ Current Rating vs. Capacitance

0505C/P Current Rating vs Capacitance

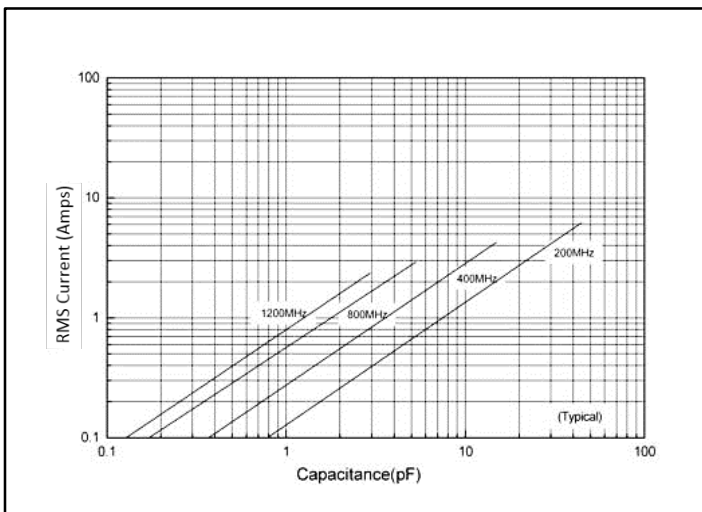

0505C Current Rating vs Capacitance

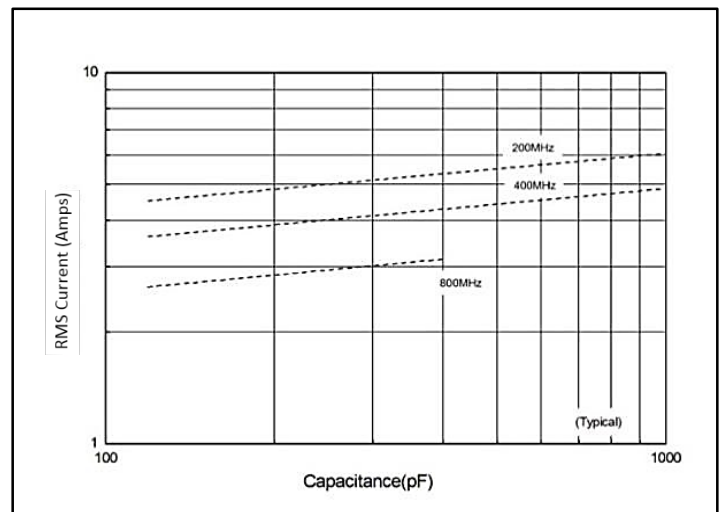

Current limits can depend on two different criteria. The first Voltage Limited Current ($I_{voltage\ lim}$, represented by the solid line), the second is Power Dissipation Limited Current ($I_{power\ diss}$).

$$I_{voltage\ lim} = \frac{\sqrt{2}}{2} I_{peak} = \frac{\sqrt{2}}{2} \times \frac{V_{rated}}{X_C} = \sqrt{2} \pi F C V_{rated}$$

$I_{power\ diss} = \sqrt{\frac{P_{dissipation}}{ESR}}$ (If the thermal resistance of the mounting surface is 40°C/W, then you will reach the power dissipated limit of 1.5W)

≠ Capacitor Application Program

PPI's brand new online Capacitor Application Program (C.A.P.) helps Engineers and Designers select capacitors according to parameters such as cap value and frequency. C.A.P. allows engineers to insert capacitors requirements (Cap value, Frequency), producing Scattering Matrices (S2P) Charts while providing options (Case Size, Terminations, Mounting), and parameters (ESR, Q, Impedance) along with Datasheets. Once engineers have determined their capacitor requirements, C.A.P. also includes online Requests For Quotes (RFQs) and/or sample requests.

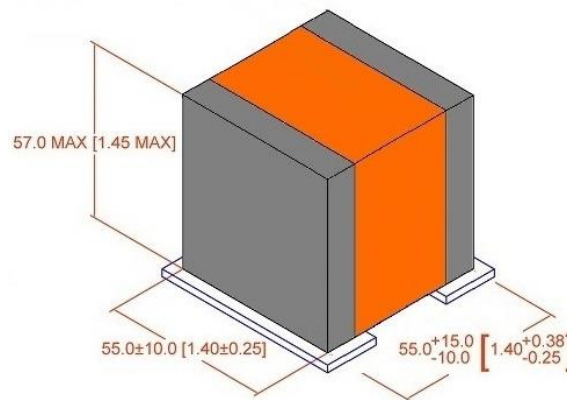

≠ Modelithics Vendor Program

PPI offers design engineers a Free 90-Day Trial license for the Modelithics PPI Component Library. This program provides engineers access to extremely accurate scalable simulation models for Passive Plus capacitors with advanced features that enable a more precise and rapid design process.

Microwave Global Models include every part value in a series and permit users to input substrate thickness, dielectric constant, and loss tangent, as well as mounting pad layout dimensions. Selected models also include capacitor orientation – vertical or horizontal – as an input. Engineers can request FREE use of the models by visiting the <https://www.modelithics.com/MVP/PPI>.



≠ Recommended Land Pattern Dimensions

Regarding Landing Patterns, please refer to IPC-7351B (table 3-5, 3-6).



Traditional High Q (>10,000) Low ESR
Multi-Layer Ceramic Capacitors

0505C/P (0.055" x 0.055")

≠ Tape & Reel Specifications

Orientation	Measurement Unit	W	P0	P1	T	F	Minimum Qty per Reel	Std Qty per Reel	Tape Material
H	in.	0.315	0.157	0.157	0.009	0.138	500	3000	Plastic
	mm	8.00	4.00	4.00	0.22	3.50			
V	in.	0.472	0.157	0.157	0.012	0.217	500	2000	
	mm	12.00	4.00	4.00	0.30	5.50			

Note: Vertical Tape & Reel not available for all values.
Contact PPI for availability.

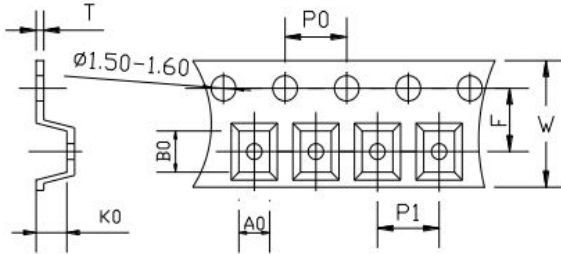

A₀B₀K₀

- Determined by component size. Typical clearance between the cavity and the component is: .50 (.002) min to .65 (.026) max for 12mm tape.
- The component cannot rotate more than 20° within the determined cavity.

≠ Engineering Design Kits

PPI offers Design Kits for engineers who are building and testing prototypes. Each kit contains 16 values; 10 pieces per value.



Kits are offered in Magnetic or Non-Magnetic Terminations. Kits are 100% RoHS compliant.

Kit Number		Value Range	Values	RoHS
MAGNETIC	NON-MAGNETIC			
DKD0505C01	DKD0505C05	0.1 - 2.0pF	0.1, 0.2, 0.3, 0.4, 0.5, 0.6, 0.7, 0.8, 0.9, 1.0, 1.2, 1.5, 1.6, 1.8, 2.0pF	✓
DKD0505P01	DKD0505P05			
DKD0505C02	DKD0505C06	1 - 10pF	1.0, 1.2, 1.5, 1.8, 2.0, 2.2, 2.4, 2.7, 3.0, 3.3, 3.9, 4.7, 5.6, 6.8, 8.2, 10pF	✓
DKD0505P02	DKD0505P06			
DKD0505C03	DKD0505C07	10 - 100pF	10, 12, 15, 18, 20, 22, 24, 27, 30, 33, 39, 47, 56, 68, 82, 100pF	✓
DKD0505P03	DKD0505P07			
DKD0505C04	DKD0505C08	100 - 1000pF	100, 120, 150, 180, 200, 220, 240, 270, 300, 330, 390, 470, 560, 680, 820, 1000pF	✓

DKD0505C01
Passive Plus Inc.
RF & Microwave Components
0505C Series 0.1 — 2.0pF
Size: 0.055" x 0.055"
TC = NP0 WVDC = 150V
Hi-Q Low ESR Capacitor Design Kit
www.passiveplus.com

DKD0505C02
Passive Plus Inc.
RF & Microwave Components
0505C Series 1.0 — 10pF
Size: 0.055" x 0.055"
TC = NP0 WVDC = 150V
Hi-Q Low ESR Capacitor Design Kit
www.passiveplus.com

DKD0505C03
Passive Plus Inc.
RF & Microwave Components
0505C Series 10 — 100pF
Size: 0.055" x 0.055"
TC = NP0 WVDC = 150V
Hi-Q Low ESR Capacitor Design Kit
www.passiveplus.com

DKD0505C04
Passive Plus Inc.
RF & Microwave Components
0505C Series 100 — 1000pF
Size: 0.055" x 0.055"
TC = NP0 WVDC = 150V
Hi-Q Low ESR Capacitor Design Kit
www.passiveplus.com

DKD0505P01
Passive Plus Inc.
RF & Microwave Components
0505P Series 0.1 — 2.0pF
Size: 0.055" x 0.055"
TC = P90 WVDC = 150V
Hi-Q Low ESR Capacitor Design Kit
www.passiveplus.com

DKD0505P02
Passive Plus Inc.
RF & Microwave Components
0505P Series 1.0 — 10pF
Size: 0.055" x 0.055"
TC = P90 WVDC = 150V
Hi-Q Low ESR Capacitor Design Kit
www.passiveplus.com

DKD0505P03
Passive Plus Inc.
RF & Microwave Components
0505P Series 10 — 100pF
Size: 0.055" x 0.055"
TC = P90 WVDC = 150V
Hi-Q Low ESR Capacitor Design Kit
www.passiveplus.com